

SUBMITTAL DATA

4LIV09HP230V1AH / 4LIV09HP230V1AO
9000 BTU/H Wall Mounted Heat Pump System

Job Name <input type="text"/>	Location <input type="text"/>	Date <input type="text"/>
Purchaser <input type="text"/>	Engineer <input type="text"/>	
Submitted to <input type="text"/>	For <input type="text"/>	
Unit Designation <input type="text"/>	Schedule No. <input type="text"/>	



YAP1F7F



4LIV09HP230V1AH



4LIV09HP230V1AO



XE71 (Optional)

GENERAL FEATURES

- AHRI Certificate: 210278963
- High Efficiency DC Inverter Technology
- Compact and Quiet Design
- Wireless Remote with LCD Display
- Wired Controller Options
- Composite Drain Pan
- Wi-Fi Included
- Low Ambient Cooling down to 0°F (Range 0°F to 115°F)
- Low Ambient Heating down to -13°F (Range -13°F to 75°F)
- Coil (Indoor and Outdoor) Copper Tube / Aluminum Fin
- Blue Colored Fin - 500 Hrs Salt Spray Tested

SPECIFICATIONS, FEATURES & FUNCTION SUMMARY

SPECIFICATIONS		4LIV09HP230V1AH / 4LIV09HP230V1AO		FEATURES & FUNCTIONS SUMMARY		4LIV09HP230V1AH / 4LIV09HP230V1AO	
System Type		HEAT PUMP					
SYSTEM PERFORMANCE							
Cooling	Min - Max	Btu/h	2800 - 10300				
	Capacity @95°F	Btu/h	9100				
Heating	Min - Max	Btu/h	2200 - 12200				
	Capacity @5°F	Btu/h					
	Capacity @17°F	Btu/h	6000				
	Capacity @47°F	W	10000				
SEER2		19.5					
EER2		11.3					
HSPF2		8.8					
COP @5°F		3.8					
COP @47°F		3.8					
Cooling Temperature Range		°F	0 - 115				
Heating Temperature Range		°F	-13 - 75				
Refrigerant Type		R410A					
INDOOR UNIT				4LIV09HP230V1AH			
Air flow (Min-Max)		CFM	159 - 353				
Sound Pressure Level (Min - Max)		dB(A)	26 - 41				
Dehumidification		pt/hr	1.69				
External Dimensions (WxHxD)		in	32-7/8 x 10-7/8 x 7-7/8				
Package Dimension (W x H x D)		in	35-1/4 x 13-5/8 x 10-11/16				
Net Weight		lbs	19.8				
Gross Weight		lbs	24.3				
OUTDOOR UNIT				4LIV09HP230V1AO			
Compressor Type		GREE G-10 / 2 - STAGE INVERTER					
Sound Pressure Level		dB(A)	51				
External Dimensions (W x H x D)		in	28-13/16 x 21-7/8 x 13				
Package Dimension (W x H x D)		in	31-5/16 x 24-3/4 x 14-13/16				
Net Weight		lbs	56.2				
Gross Weight		lbs	61.7				
REFRIGERANT PIPING							
Refrigerant Charge - R410A		oz	24.7				
Additional Charge		oz/ft	0.2				
Line Set Size (Liquid - Gas) - Flared Connections		in	1/4 - 3/8				
Pre-Charge Length		ft	25				
Pipe Length (Min - Max)		ft	10 - 66				
Max. Pipe Elevation		ft	39				
ELECTRICAL							
Power Supply		208 - 230V / 1Ph /60Hz					
Voltage Range (Min - Max)		VAC	187 - 253				
Rated Current - Cooling		A	6.5				
Rated Current - Heating		A	7				
MCA		A	9				
MOCP		A	15				
Suggested Breaker Size		A	15				
Main Power Wire Size		AWG	Per Local Code				
Interconnecting Wire Size		AWG	14 / 4				
SYSTEM FEATURES							
Inverter Type		G10					
Ultra Low Frequency Torque Control		Yes					
Power Factor Correction		Yes					
Compressor Type		High Efficiency Rotary					
Refrigerant Type		R410A					
Basepan With Electric Heater		Yes					
Compressor With Electric Heater		Yes					
Outdoor Fin Coating (Color:Blue)		Acrylic-Resin/Anti-Corrosive					
Intelligent Defrosting		Yes					
Force Defrosting		Yes					
Intelligent Preheating		Yes					
Low Voltage Startup		Yes					
Memory/Power Failure Recovery		Yes					
Self Diagnosis		Yes					
Wired Controller Interface (XE71)		Yes					
WiFi Included		Yes					
Indoor Fan Type		Crossflow					
Multi Fan Speeds		4 Speeds					
Indoor Unit Display		Yes					
Auxiliary Electrical Heater		No					
Ventilation (Outdoor Air)		No					
REMOTE CONTROLLER FUNCTIONS							
Auto Mode		Yes					
Auto Fan		Yes					
Manual Horizontal Swing		Yes					
Auto Swing (Vertical Auto Swing)		Yes					
Clock on Remote Controller		Yes					
Dry Mode		Yes					
Dry Anti-Mildew (X-Fan) Mode		Yes					
Energy Saving Mode		Yes					
Dirty Filter Alert		No					
I Feel Function		Yes					
Lock on Remote Controller		Yes					
Quiet Mode		No					
Room Temperature Display		Yes					
Sleep Mode		Yes					
Timer Mode		Yes					
Turbo Mode		Yes					
Display On/Off Control		Yes					
Freeze Guard Mode (46°F)		Yes					
Display On/Off Control		Yes					

DIMENSIONS

INDOOR UNIT

Unit: inch

4LIV09HP230V1AH	
DIMENSIONS	
W	32-7/8
H	10-7/8
D	7-7/8
W1	7-3/64
W2	18-5/32
W3	7-11/16

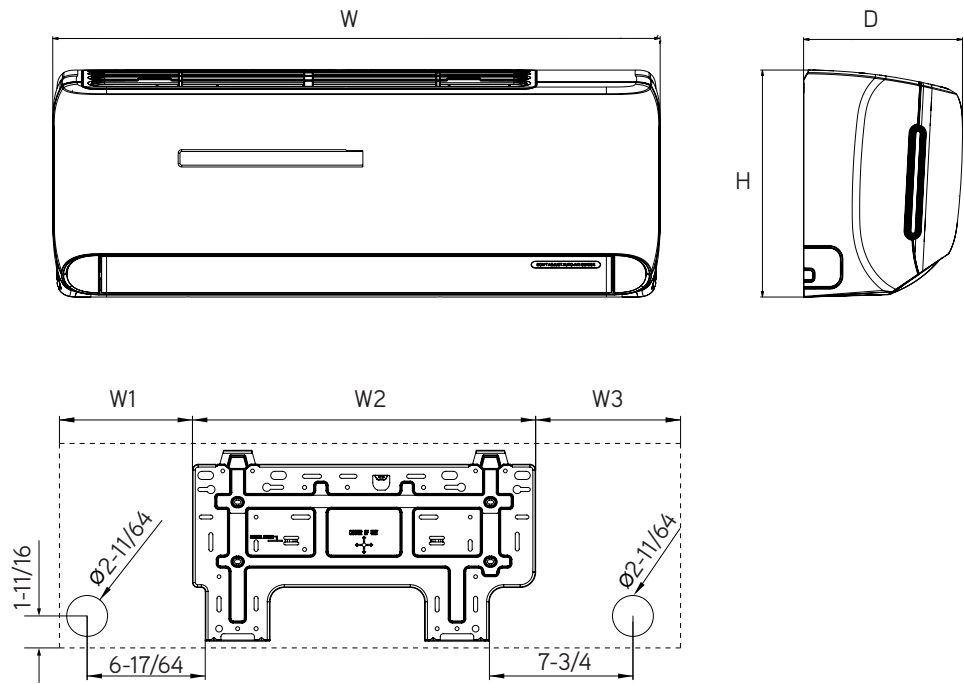

OUTDOOR UNIT

Unit: inch

4LIV09HP230V1AO	
DIMENSIONS	
A	26-37/64
B	28-13/16
C	21-7/8
D	11-7/32
E	13
F	17-29/32
G	12-13/64

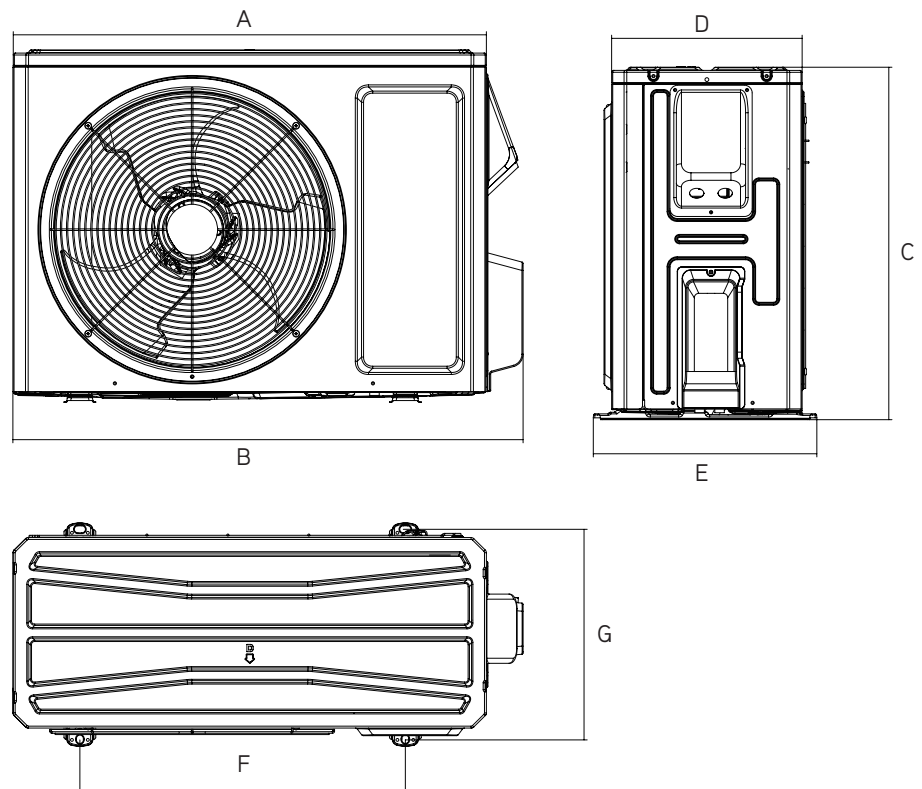

CLEARANCES

INDOOR UNIT Minimum clearance

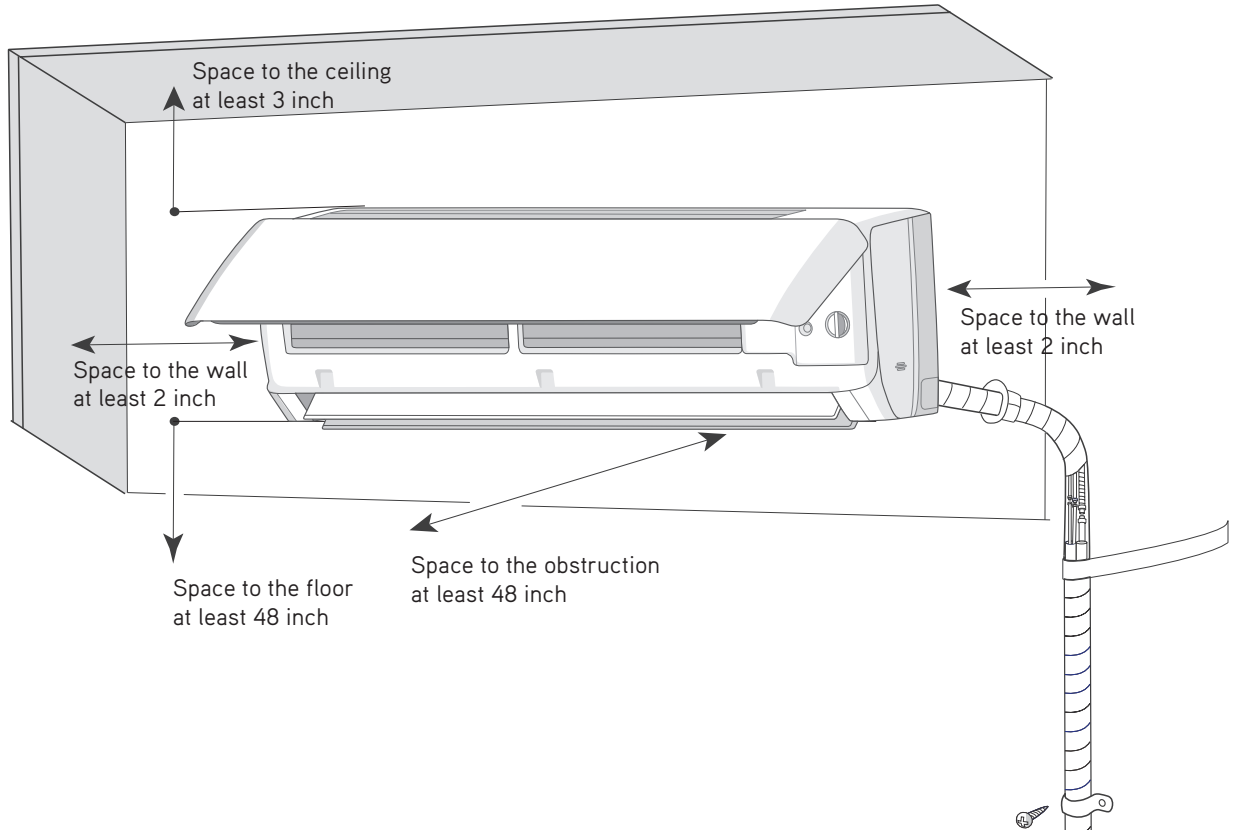

OUTDOOR UNIT Minimum clearance

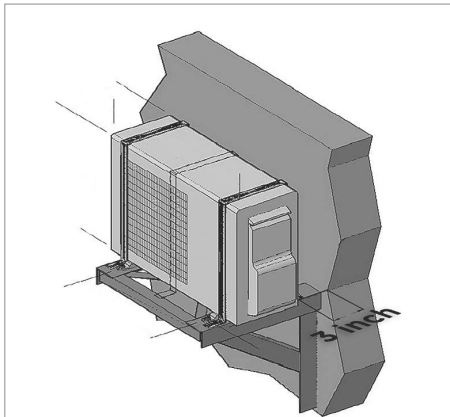

NOTE:

If bottom of the unit is free of airflow obstructions similar to the mounting bracket figure, the clearance to the wall on the back can be reduced to 3 inches.

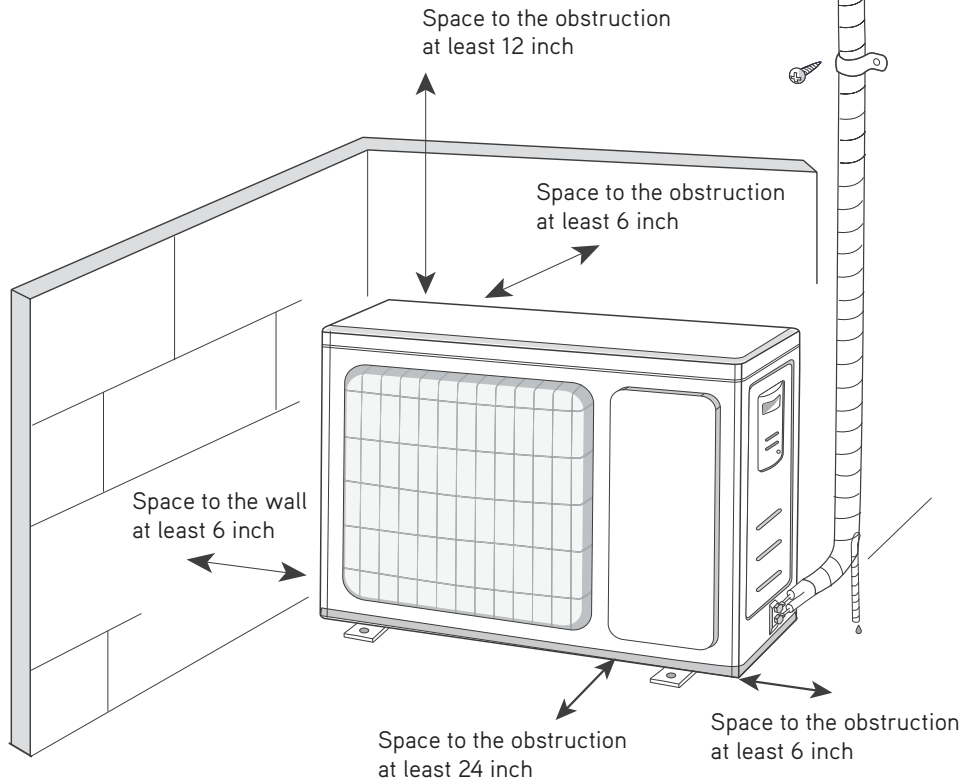

Specifications are subject to change without notice. Manufacturer reserves the right to discontinue or modify specifications or designs without notice or without incurring obligations. All Rights reserved.